



# BeagleBone und Raspberry Pi Ein Überblick

Jochen Krapf, Christian Besenreiter

KNF-Kongress 2013

# Agenda

- **Boards**
  - **BBB**
  - **RPi**
- **Hardware**
- **Software**
- **Entwicklung**
- **Fazit / Erfahrungen**

# Boards:



**Boards**

# Boards: BeagleBone Black (BBB)

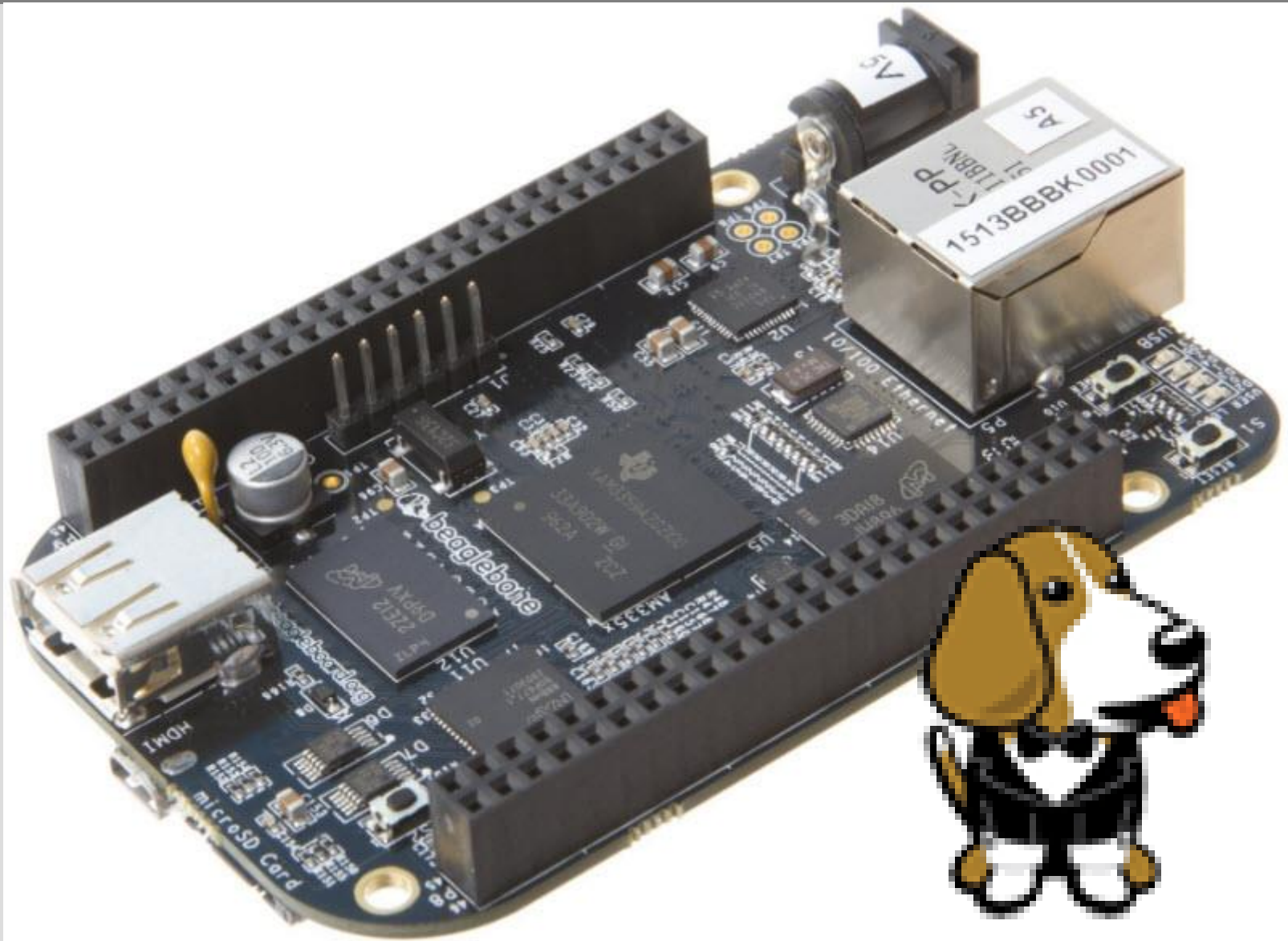

# Boards: Raspberry Pi B (RPI)

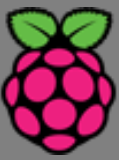

# Boards → Features (Gemeinsamkeiten)



<b>Feature</b>	<b>BBB + RPi</b>
<b>Größe</b>	<b>Scheck-Karte</b>
<b>Geschwindigkeit</b>	<b>700...1000MHz</b>
<b>Standard I/O</b>	<b>viele...</b>
<b>Port I/O</b>	<b>viele...</b>
<b>Betriebssystem</b>	<b>Linux (kein Embedded...)</b>
<b>Entwicklung</b>	<b>einfach...</b>

**HW:**







**Hardware**

# HW → Intern



























<b>Feature</b>	<b>BBB</b> 	<b>RPi</b> 
<b>CPU</b>	<b>Cortex A8</b> <b>1GHz</b>	<b>ARM 11</b> <b>700MHz</b>
<b>GPU</b>	- (nur Framer) <b>1280x1024</b>	<b>VideoCore IV</b> Decoder H264, MPEG2 <b>1920x1080</b>
<b>RAM</b>	<b>512MB</b> (400MHz)	<b>512MB</b> (400MHz)
<b>Flash</b>	<b>2GB eMMC</b>	-
<b>SATA, PCI...</b>	-	-



# HW → Standard I/O

<b>Feature</b>	<b>BBB</b> 	<b>RPi</b> 
<b>Grafik digital</b>	<b>MicroHDMI</b>	<b>HDMI</b>
<b>Grafik analog</b>	-	<b>FBAS (PAL, NTSC)</b>
<b>Audio analog</b>	-	<b>Stereo (Klinke)</b>
<b>Ethernet</b>	<b>10/100</b>	<b>10/100 (über USB)</b>
<b>USB Device</b>	<b>1x miniUSB</b>	<b>1x USB-B</b>
<b>USB Host</b>	<b>1x USB-A</b>	<b>2x USB-A</b>
<b>SD-Slot</b>	<b>MicroSD</b>	<b>SD (+System)</b>
<b>HotPlug</b>		

# HW → Port I/O

Feature	BBB 	RPi 
Digital I/O	   (65)	 (12 über I <sup>2</sup> C)
Analog In		
I <sup>2</sup> C	 	 
Seriell (TTL, 3,3V)	 	
SPI	 	
CAN		
DSI, CSI		 
Timer/PWM	 	

# HW → BBB I/O

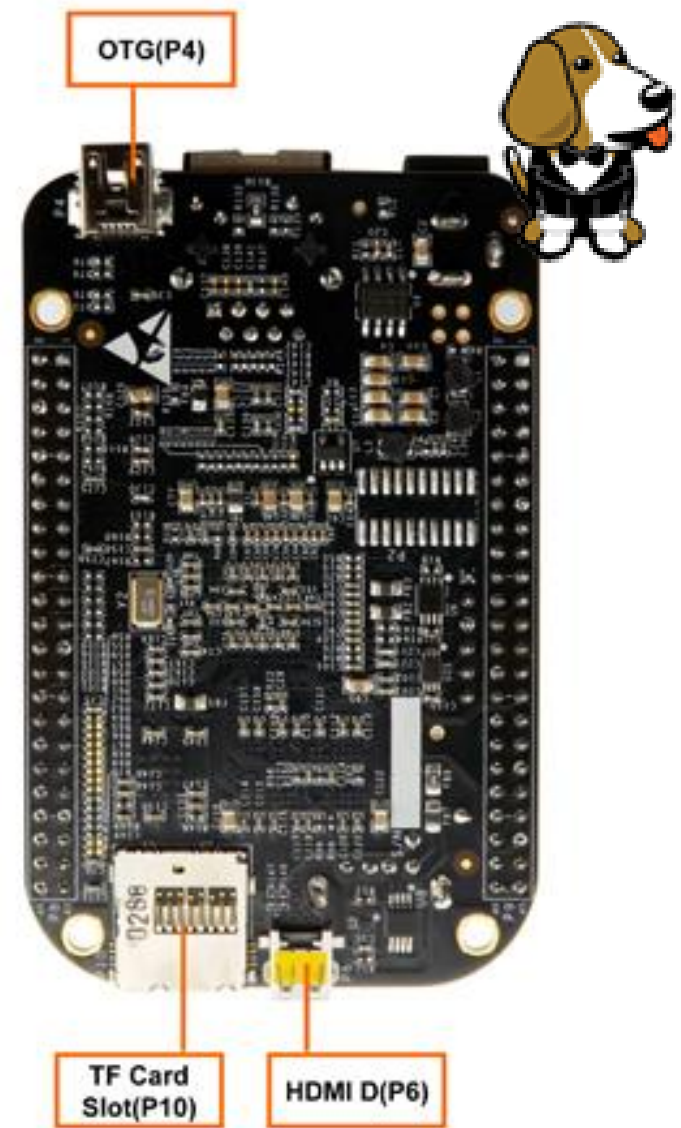
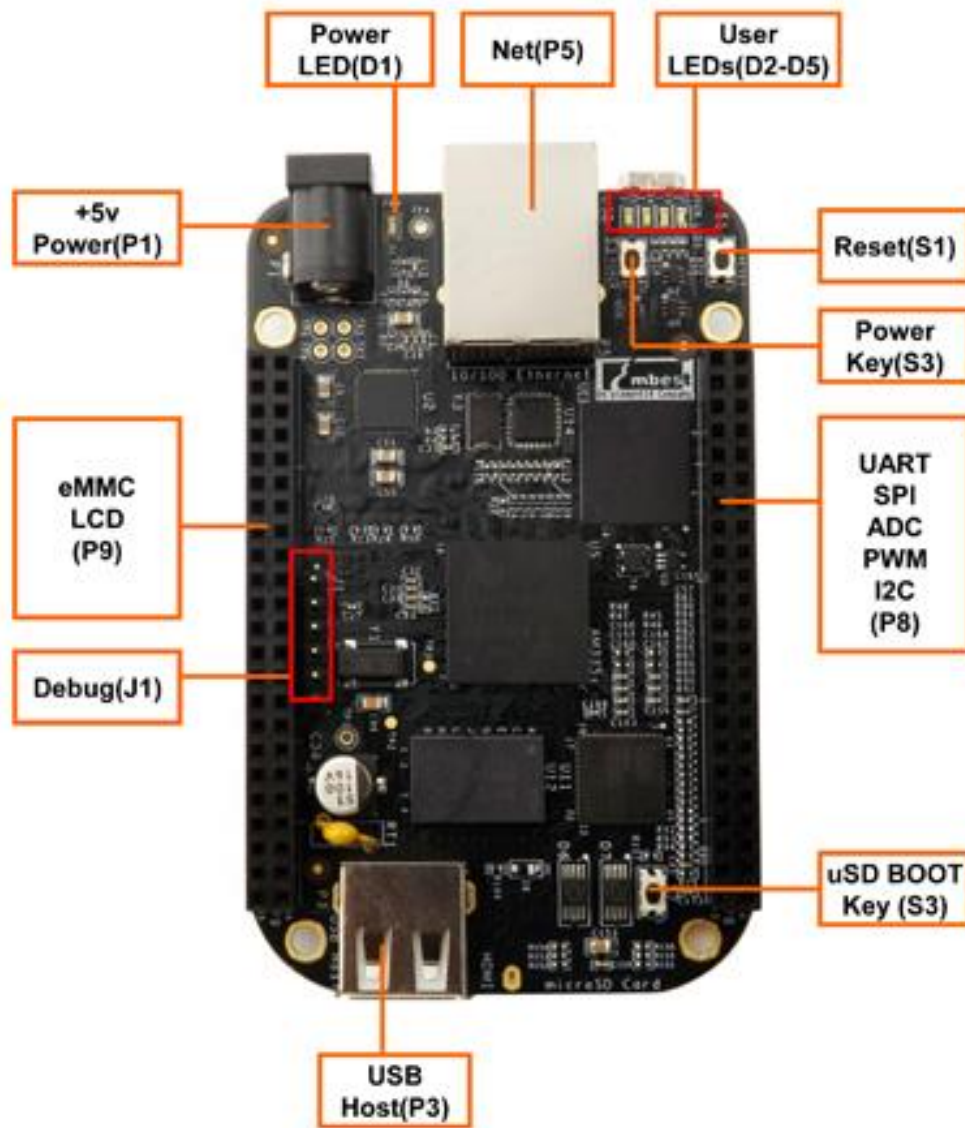

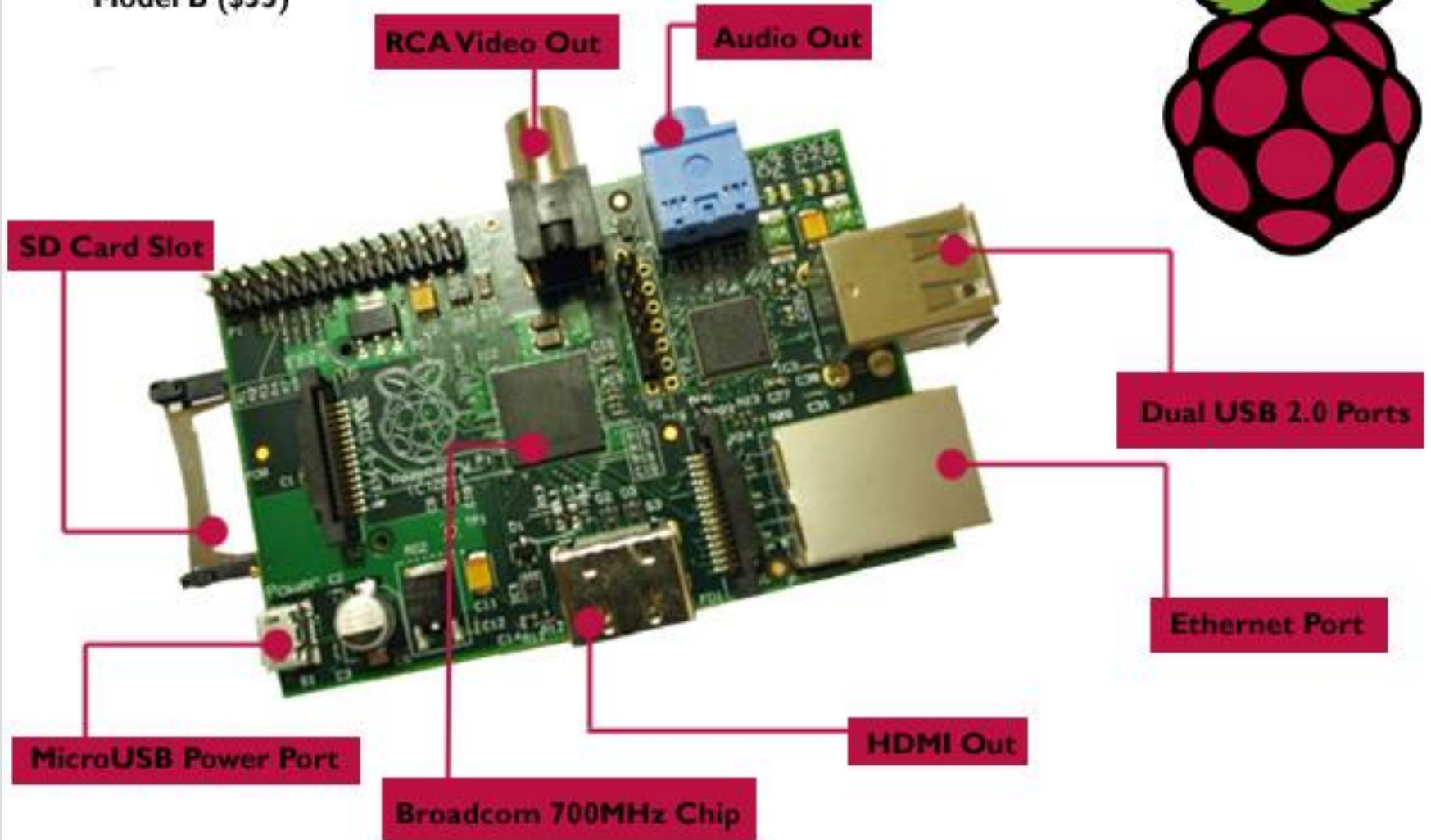
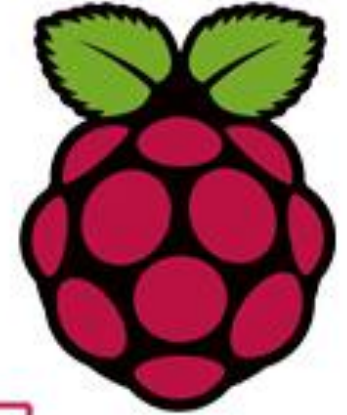

# HW → RPi I/O

## Raspberry Pi Model B (\$35)



# HW → Power

Feature	BBB 	RPi 
Spannung	5V	5V
Stecker	USB/Rundst.	USB
Leistung (ohne Peripherie)	<b>2.5</b> Watt	<b>3.5</b> Watt
Kühlung	nein	nein/passiv

→ 24/7 Server

**SW:**



**Linux-Software**

# SW → Betriebssysteme

**BBB** 

**TI:** Android, Linux, StarterWare (no OS)

**Linux:** Angstrom Distribution, Ubuntu,  
Debian, ArchLinux, Gentoo, Sabayon,  
Buildroot, Erlang, Fedora

**Andere:** QNX, FreeBSD

**RPi** 

**Linux: ...**

**XBMC Media Center**

# SW: Live







**R&D:**

**Entwicklung  
eigener  
Software/Hardware**

# R&D → Sprachen

<b>Feature</b>	<b>BBB</b> 	<b>RPi</b> 
<b>Einsteiger</b>	<b>BoneScript (JavaScript)</b>	<b>Python</b>
<b>C/C++</b>	<b>gcc</b>	<b>gcc</b>
<b>Andere</b>	<b>Alle mit File-I/O</b>	<b>Alle mit File-I/O</b>

# R&D → Beispiel LED in BoneScript

```
var b = require('bonescript');
var led = "P8_13";
var state = 0;

b.pinMode(led, 'out');

toggleLED = function()
{
    state = state ? 0 : 1;
    b.digitalWrite(led, state);
};

timer = setInterval(toggleLED, 100);
```

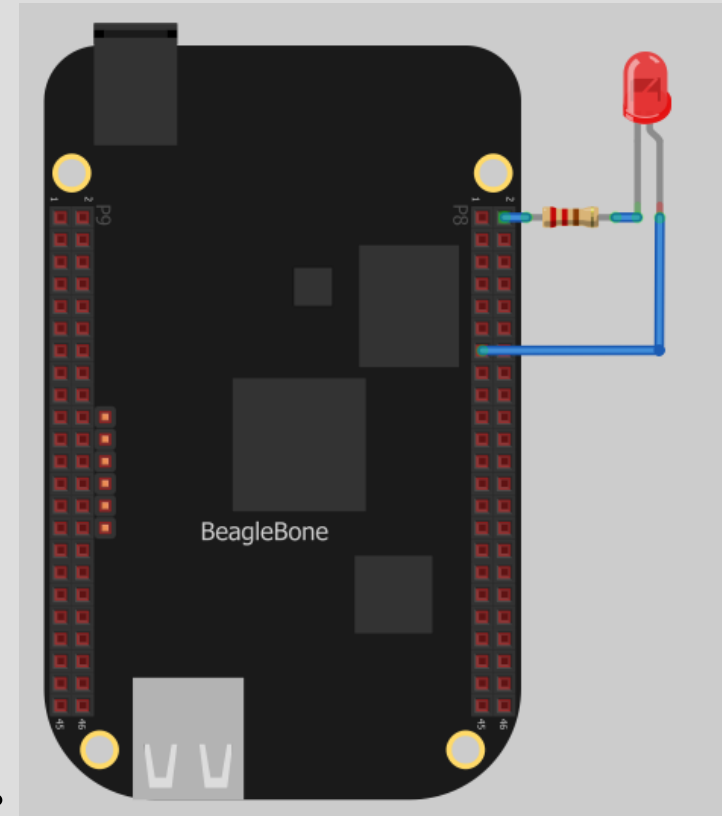

# R&D → Beispiel IDE



The IDE interface shows a project named 'cloud9' with a file tree on the left containing folders like 'bone101', 'bonescript', and 'node\_modules', and files like 'analog.js', 'blinkled.js', 'bone101.js', 'fade.js', 'fade.js~', 'input.js', 'input2.js', 'LICENSE', 'loops.js', 'parallel.js', and 'README.txt'. The main editor displays the code for 'blinkled.js':

```
1 require('bonescript');
2
3 ledPin = bone.P8_3;
4 ledPin2 = bone.USR3;
5
6 setup = function() {
7   pinMode(ledPin, OUTPUT);
8   pinMode(ledPin2, OUTPUT);
9 };
10
11 loop = function() {
12   digitalWrite(ledPin, HIGH);
13   digitalWrite(ledPin2, HIGH);
14   delay(1000);
15   digitalWrite(ledPin, LOW);
16   digitalWrite(ledPin2, LOW);
17   delay(1000);
18 };
19
```

The console output shows the following messages:

```
bmp085 driver load failed.
info - socket.io started
Listening for new socket.io clients
info - socket.io started
Listening for new socket.io clients
warn - error raised: Error: listen EADDRINUSE
info - handshake authorized 90131346198524604
Client connected
Spawning bash
New client connected
info - transport end
```

# R&D → Beispiel LED in C 1/2



```
#include <stdio.h>
#include <unistd.h>
#include <string.h>
using namespace std;
```

```
int main(int argc, char** argv) {
FILE *myHandle = NULL;
```

```
// Export the pin
```

```
myHandle = fopen ("/sys/class/gpio/export", "ab");
fwrite ("60", sizeof(char), 2, myHandle);
fclose (myHandle);
```

ls /sys/class/gpio/gpio60/

```
// Set direction of the pin to an output
```

```
myHandle = fopen ("/sys/class/gpio/gpio60/direction", "rb+");
fwrite ("out", sizeof(char), 3, myHandle);
fclose (myHandle);
```

```
...
```

# R&D → Beispiel LED in C 2/2



...

```
for (int i=0; i<times; i++)
```

```
{
```

```
    // Set output to high
```

```
    myHandle = fopen ("/sys/class/gpio/gpio60/value", "rb;
```

```
    fwrite ("1", sizeof(char), 1, myHandle);
```

```
    fclose (myHandle);
```

```
    sleep (1); // wait for 1 sec
```

```
    ...
```

# R&D → Device Tree (DS1820 an 1-Wire)

```
/dts-v1/;
/plugin/;
/ {
    compatible = "ti,beaglebone", "ti,beaglebone-black";

    part-number = "BB-W1";
    version = "00A0";

    /* state the resources this
    exclusive-use =
        /* the pin head
        "P9.22",
        /* the hardware
        "gpio0_2";

    fragment@0 {
        target = <&am33xx_pinmux>;
        __overlay__ {
            dallas_w1_pins: pinmux_dallas_w1_pins {
                pinctrl-single,pins = <0x150 0x37>;
            };
        };

    fragment@1 {
        target = <&ocp>;
        __overlay__ {
            onewire@0 {
                compatible = "w1-gpio";
                pinctrl-names = "default";
                pinctrl-0 = <&dallas_w1_pins>;
                status = "okay";
                gpios = <&gpio1 2 0>;
            };
        };
    };
};
```

```
dtc -O dtb -o BB-W1-00A0.dtbo -b 0 -@ BB-W1-00A0.dts
cp BB-W1-00A0.dtbo /lib/firmware/
echo BB-W1:00A0 > /sys/devices/bone_capemgr.9/slots
echo /sys/bus/w1/devices/10-000802ad4fae/w1_slave ...
```



# R&D → Beispiel Text-LCD

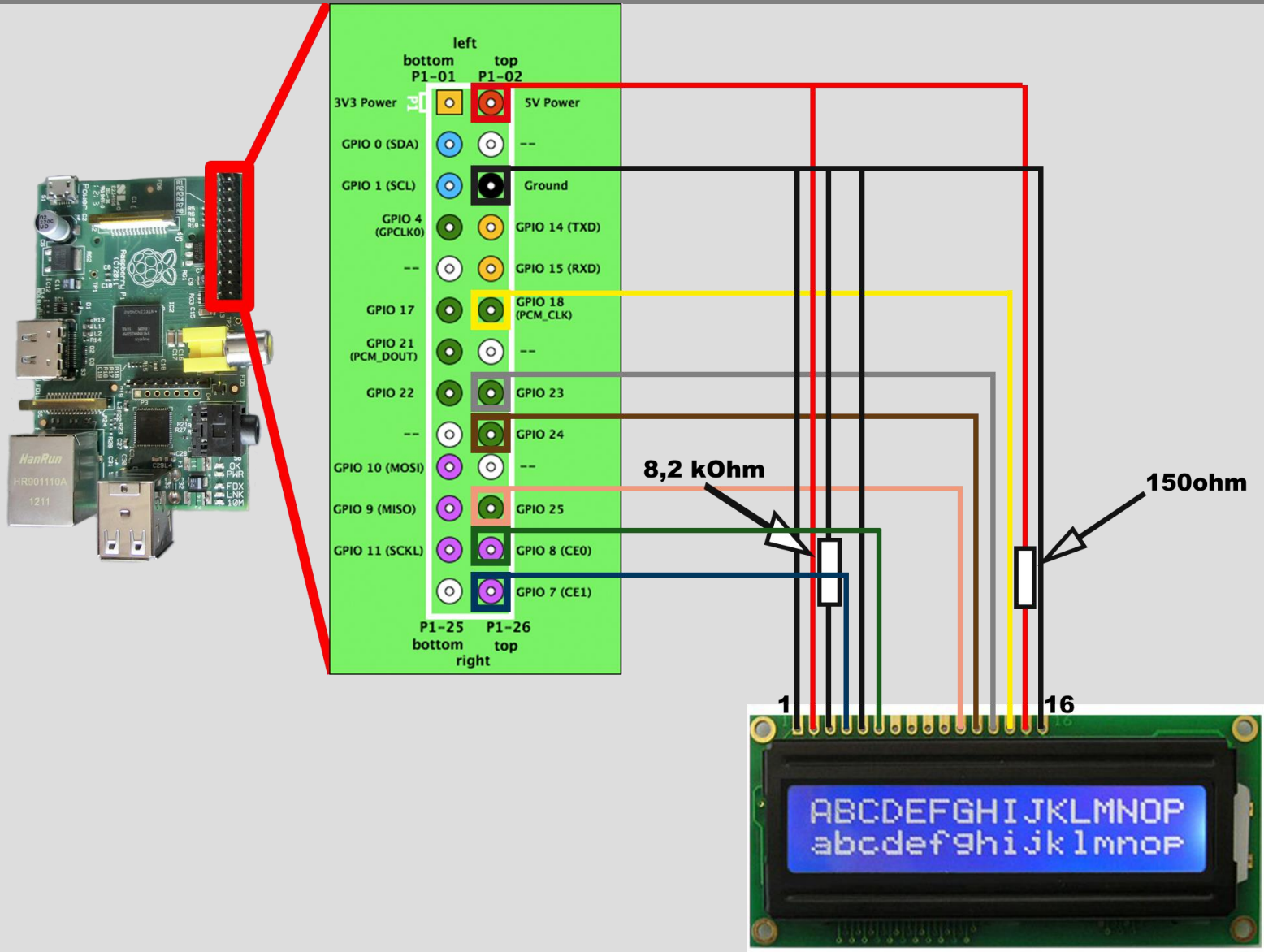



# R&D → BBB Capes



**Breadboard**



**Breakout**



**7" LCD**



**DVI-D**

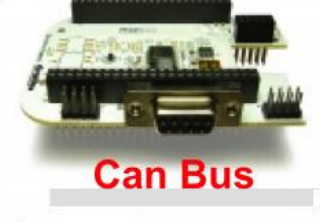

**Can Bus**



**RS232**



**RS485**



**4.3" LCD**



**VGA**



**Battery**



**Profibus**



**Proto**



**RF-CC1101  
CC2500  
CC2530**



**3.5" LCD**



**Weather**



**Camera**



**CAN**



**DVI-D w/  
Audio**



**Audio**



**Radar**



**BeBoPr**



**LVDS**

# R&D → RPi Capes

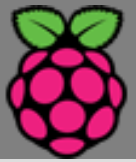



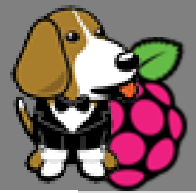





























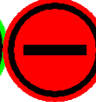

# R&D → BBB zu RPi Cape



# Fazit:

**Fazit / Erfahrungen**

# Fazit → Über alles

Feature	BBB 	RPi 
Linux SW	  	  
Linux GUI		 
Media Center		 
Std. HW	 	
Exp. HW	   	 
Leistung	   	  
Preis	~50€	~35€ +SD-Card
Community	 	  

# Fazit → Mehrere CPUs: Gertboard



**AtMega 328**

**AtMega 48**

**IRDA (über AtMega)**

**RTC + Batterie**

**Arduino-Shield**

**5V tolerant**

# Bücher

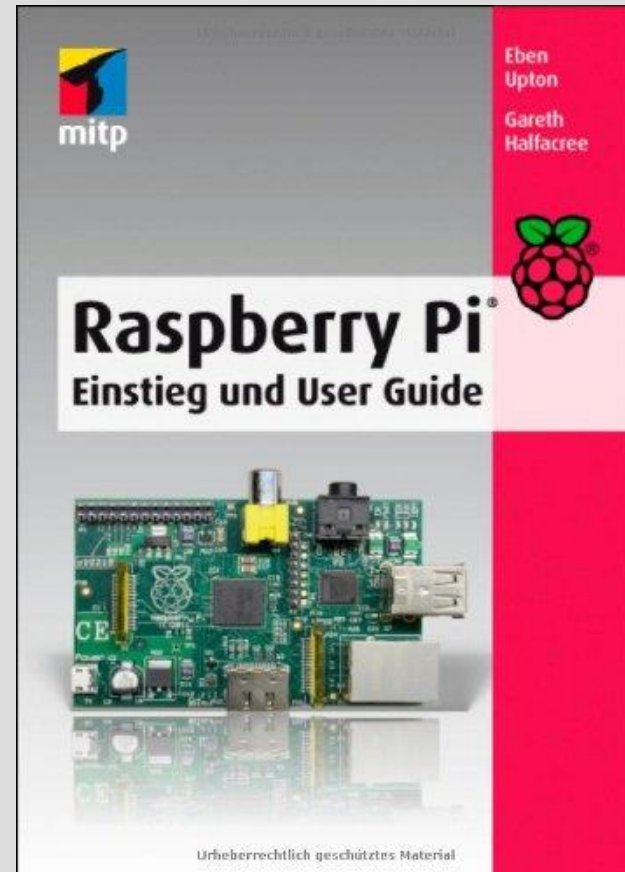
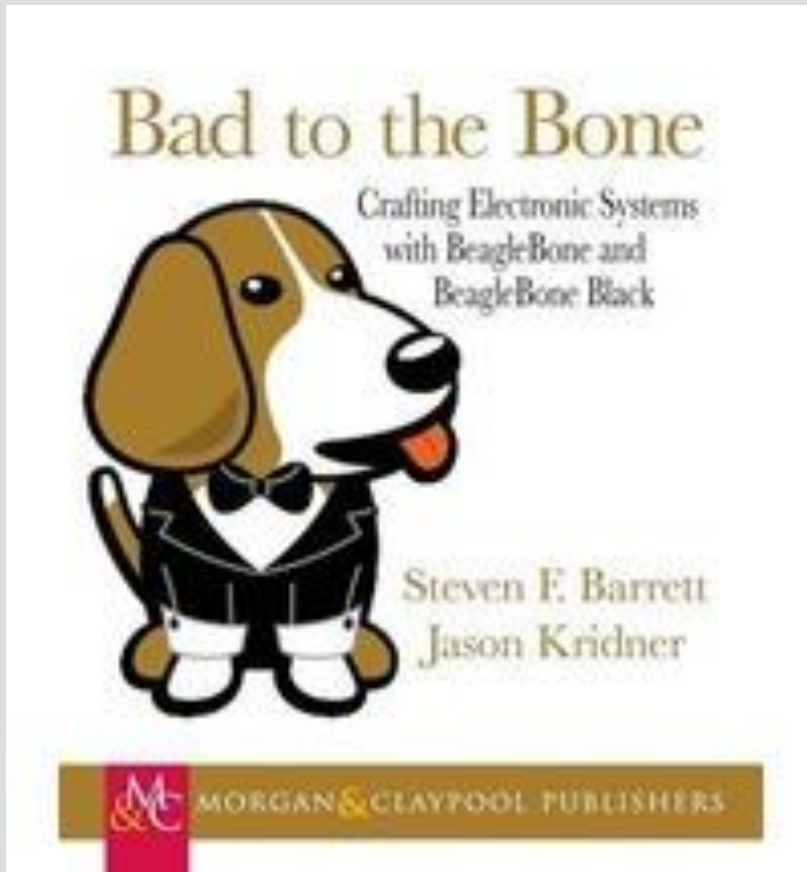

# Ausblick → Cubieboard3

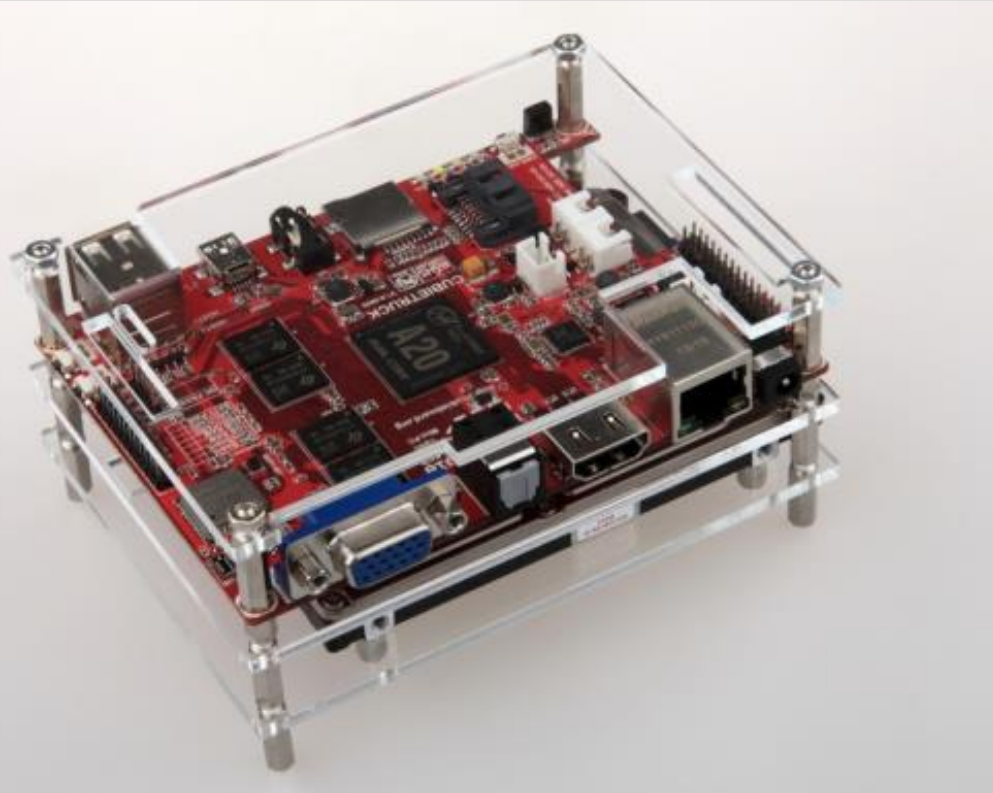

**Cortex A20**  
**DualCore**

**2GB RAM**

**HDMI 1080p**

**VGA**

**SATA 2.0**

**1G Ethernet**

**Wifi+BT**

**Lubuntu/Fedora**





**Alle Logos, Marken und Namen sind Eigentum der jeweiligen Firmen**

